

8 7 6 5 4 3 2 1

F
E
D
C
B
A

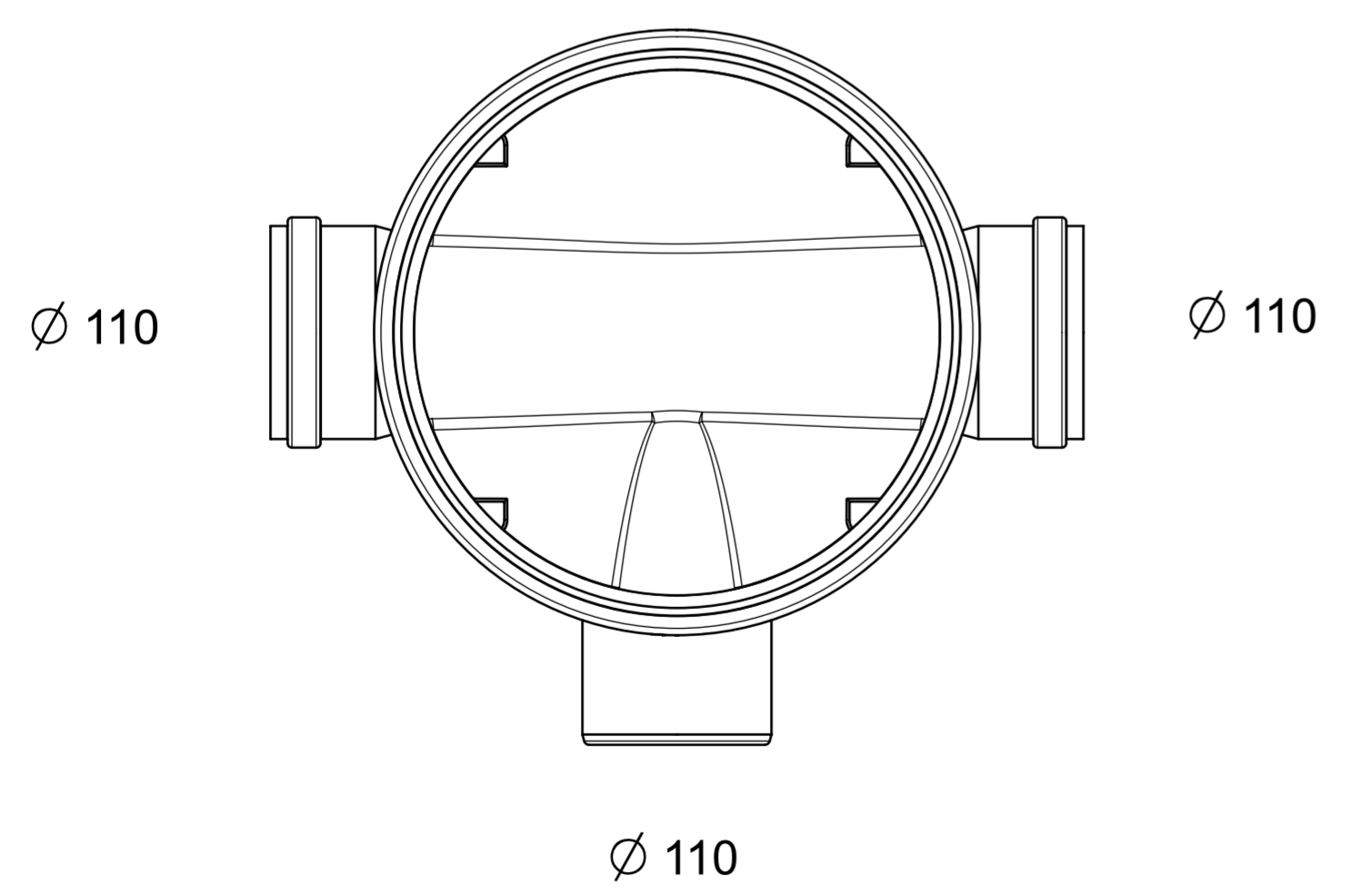
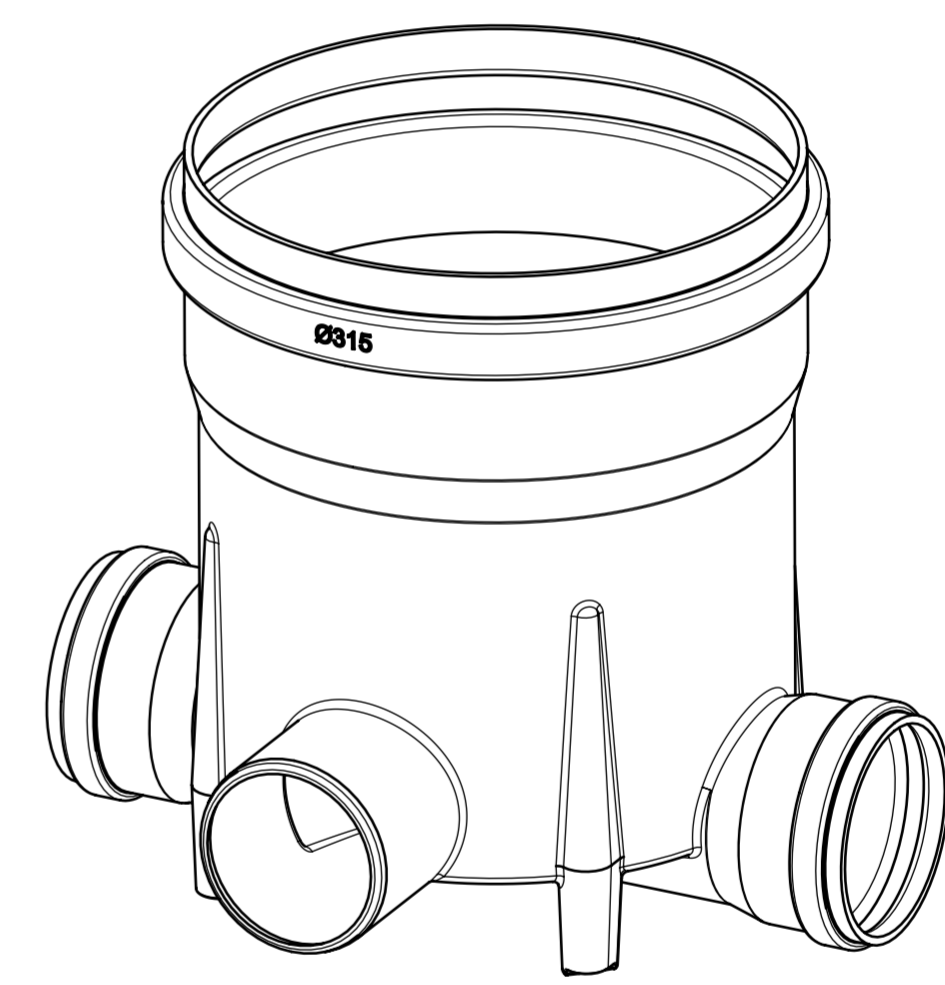
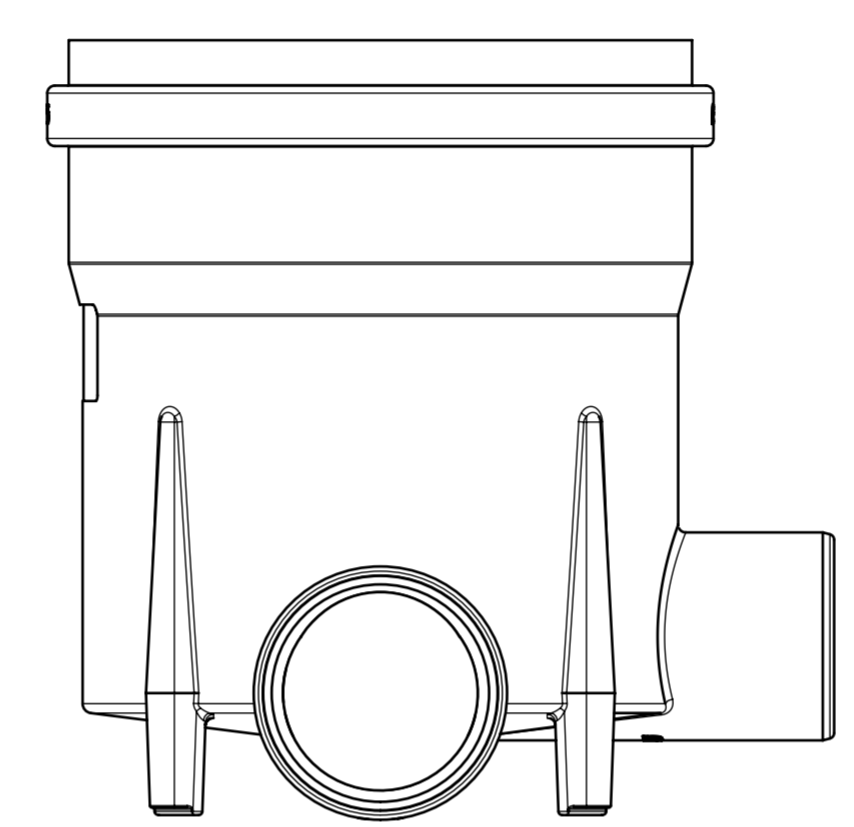
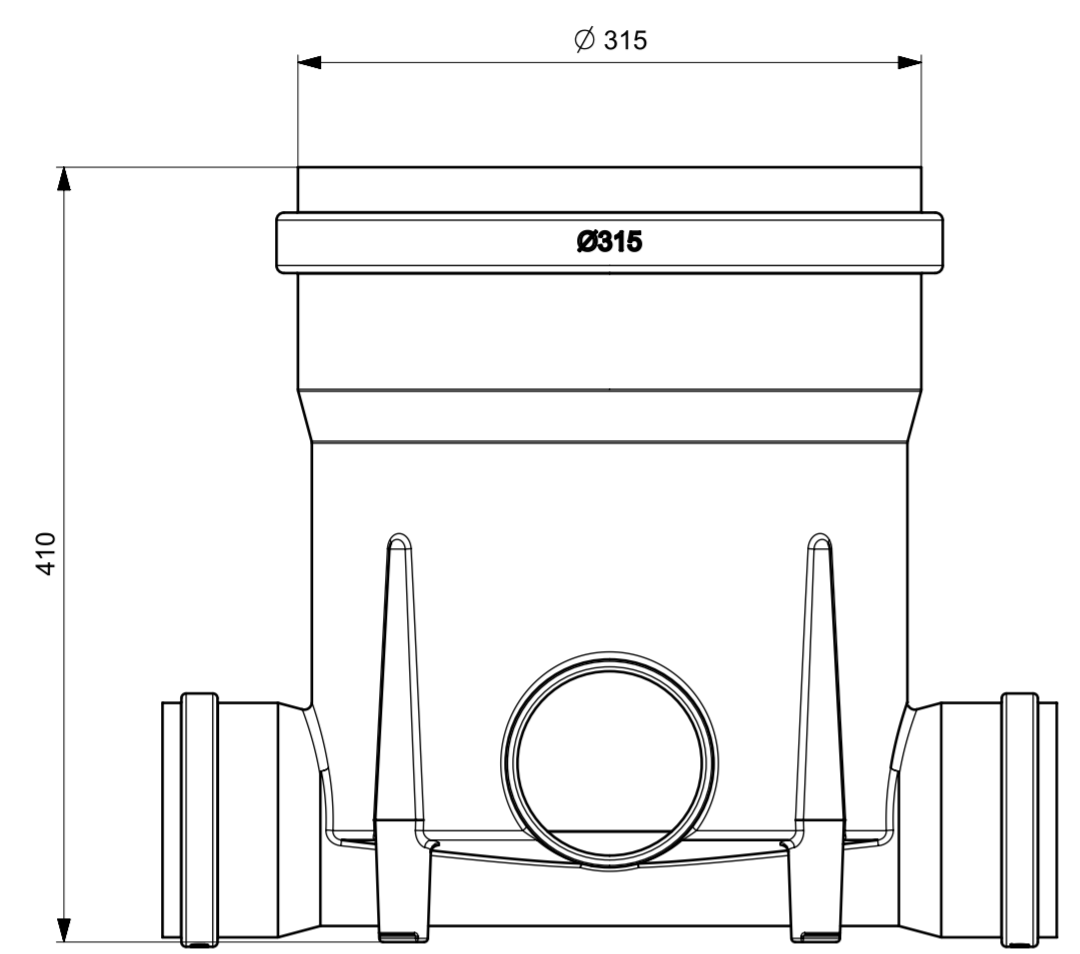
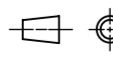

Linear tolerances	Surface roughness	Shape and positioning tolerances	Bend tolerances	Finishing
Drawing name				Material
PE NAZICHTPUT 23				PE
Drawn by	Name	Date	 Drawing number PE NAZICHTPUT 23_2D_1.01	Sheet 1 of 1
Approved by	unit : MM			Scale 1 : 4
DS PLASTICS WATERTIGHT SOLUTIONS			DS PLASTICS N.V. Mosten 18 9160 Lokeren T: +32 (0)9 280 78 80	All rights reserved. No parts of this concept may be reproduced in any form or by any means without the prior written permission of DS PLASTICS N.V.

8 7 6 5 4 3 2 1